



CONCERTINA COUNTER

01.01.2020



CONCERTINA COUNTER

Concertina is an adjustable and ergonomic work station. The counter takes the comfort of the user into account and improves the work habit of library and office employees. The height adjustability gives the user the flexibility to change work postures during the course of the day to break potentially health-impairing routines or to adjust the work station to fit several individuals or tasks simultaneously.

The counter is often placed at the entrance area and is the first point of contact, thus the first impression of the library. Therefore, the counter should be welcoming, inviting and tempt people to enter and explore the library.

With its aesthetic and functional design the Concertina counter offers a flexible system with a range of options to fit the individual needs.

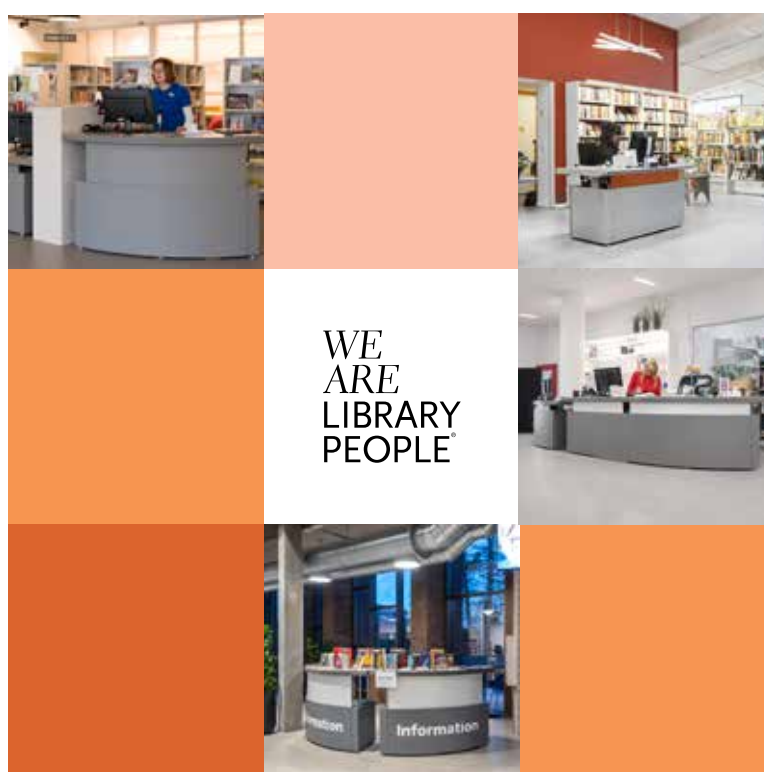

DESIGN OPTIONS..... 5

TECHNICAL SPECIFICATIONS..... 8

CONFIGURATIONS

CONCERTINA COUNTER..... 11

Configuration 13

COMPONENTS

BASE MODULES

Straight base module - steel front panel 14

Straight base module - wooden front panel 15

Curved base module - steel front panel 16

Curved base module - wooden front panel 17

INTERMEDIATE MODULES

Intermediate module 18

COUNTER TOPS

Counter top for straight base module 19

Counter top for straight base module - with low rail 20

Counter top for straight base module - with high rail 21

Counter top for 45° curved base module 22

Counter top for 45° curved base module - with low rail 23

Counter top for 45° curved base module - with high rail 24

Counter top for 60° curved base module 25

Counter top for 60° curved base module - with low rail 26

Counter top for 60° curved base module - with high rail 27

ACCESSORIES

Accessories 29



DESIGN OPTIONS

STEEL COMPONENTS (see overview page 6)

PRICE GROUPS STEEL

Price Group 1: no surcharge.

Price Group 2: surcharge of 7%.

Price Group 3: other RAL/NCS colours with a starter fee of EUR 250 and with a surcharge of 15%. A higher surcharge for colours with "metallic" look or different surface textures must be expected.

See specific colour for steel gloss specification. Special requests outside specified gloss range are not covered by the above surcharges.

LOWER FRONT PANEL AND END FRAMES

The lower front panel and end frames on a Concertina base module is as standard produced in Concertina grey (A29) but can be ordered in other standard colours with a surcharge per module of
If other colours are requested, please see page 6.

UPPER FRONT PANEL

The upper front panel on a Concertina base module is as standard delivered in the colours shown on page 6.

- The actuator is only available in White Aluminium RAL 9006 (A14).

- As a standard, the rubber edging and bumpers are produced in grey, but are available in black at no surcharge.

COUNTER TOPS

The steel parts on the counter tops are as standard produced in Concertina grey (A29). If other colours are requested, please see page 6.

WOODEN COMPONENTS (see overview page 7)

PRICE GROUP PAINTED

Price Group A: no surcharge.

A surcharge of 25% for colours with "metallic" look or different surface textures must be expected.

PRICE GROUPS VENEER

Price Group A: no surcharge.

Price Group B: surcharge of 15%

Price Group C: surcharge of 20%

The veneers can also be stained for a surcharge of 25%, please ask customer service. Samples will be forwarded for approval.

LOWER FRONT PANEL

The lower wooden front panel on a Concertina counter is as standard produced in light steamed beech (55) or birch (69) veneer.

COUNTER TOPS, RAIL TOPS AND BAG SHELVES

The counter tops, rail tops and bag shelves are as standard produced in grey laminate "Dandekor Etronit MB 311 NCS 4502-B Grey" (#185) or grey linoleum "Forbo desktop elegance 4175 Grey" (#257).

Note:

Some special laminates and linoleums may release a surcharge.

Counter tops and rail tops cannot be produced in veneer.

DRAWER PEDESTALS

The drawer pedestals are as standard produced in Concertina grey (A29). The drawer pedestals can be painted in any NCS or RAL colour without extra surcharge.

DESIGN OPTIONS

STANDARD COLOURS AND FINISHES FOR STEEL COMPONENTS

PRICE GROUP 1 - SMOOTH FINISH (no surcharge)



A03
Traffic white
RAL 9016
Gloss 75-90



A02
Oyster white
RAL 1013
Gloss 40-50

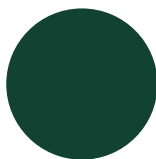

A22
Moss green
RAL 6005
Gloss 71-85

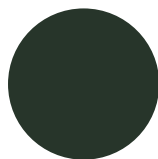

A26
Fir green
RAL 6009
Gloss 71-85

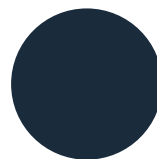

A12
Steel blue
RAL 5011
Gloss 71-85



A13
Light grey
RAL 7035
Gloss 71-85

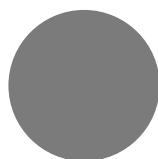

A15
Dusty grey
RAL 7037
Gloss 71-85

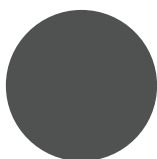

A16
Traffic grey
RAL 7043
Gloss 71-85

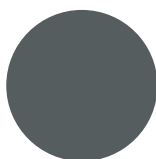

A17
Basalt grey
RAL 7012
Gloss 71-85

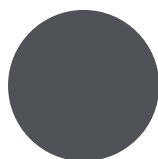

A18
Slate grey
RAL 7015
Gloss 71-85

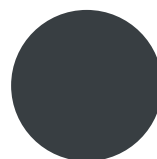

A19
Anthracite grey
RAL 7016
Gloss 71-85

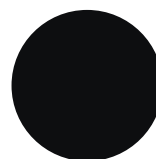

A25
Jet black
RAL 9005
Gloss 71-85

PRICE GROUP 2 - SMOOTH FINISH (7% surcharge)



A01
Pure white
RAL 9010
Gloss 71-85

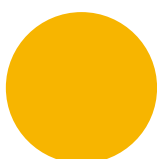

A04
Traffic yellow
RAL 1023
Gloss 71-85

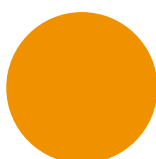

A05
Sun yellow
RAL 1037
Gloss 71-85

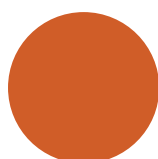

A06
Signal orange
RAL 2010
Gloss 71-85

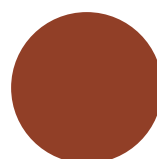

A07
Pearl orange
RAL 2013
Gloss 65-85

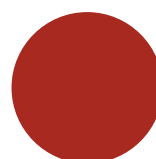

A08
Flame red
RAL 3000
Gloss 71-85

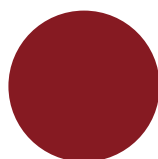

A09
Ruby red
RAL 3003
Gloss 71-85

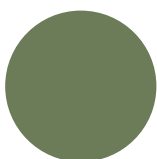

A21
Reseda green
RAL 6011
Gloss 71-85

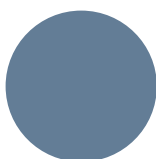

A10
Pigeon blue
RAL 5014
Gloss 71-85

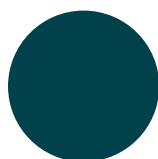

A11
Ocean blue
RAL 5020
Gloss 71-85

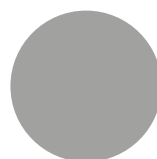

A14
White aluminium
RAL 9006
Gloss 50-70

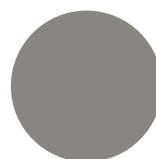

A31
Grey aluminium
RAL 9007
Gloss 50-70

PRICE GROUP 2 - TEXTURED FINISH (7% surcharge)



A27
Pure white
RAL 9010

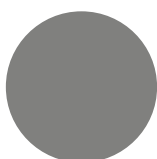

A29
Concertina grey

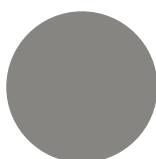

A28
Grey aluminium
RAL 9007

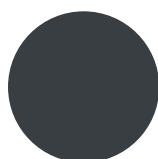

A23
Anthracite grey
RAL 7016

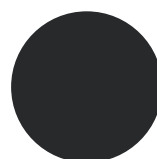

A24
Graphite black
RAL 9011

DESIGN OPTIONS

STANDARD COLOURS AND FINISHES FOR WOODEN COMPONENTS

PRICE GROUP A - PAINTED (no surcharge except metallic and textured surfaces)

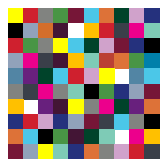

Any RAL/NCS colour

Gloss 20-30

PRICE GROUP A - VENEER (no surcharge)



69
Birch



55
Light steamed beech

PRICE GROUP B - VENEER (15% surcharge)



66
Oak

PRICE GROUP C - VENEER (20% surcharge)



67
Maple



68
Ash

TECHNICAL SPECIFICATIONS

GENERAL SPECIFICATIONS

CONSTRUCTION

The construction of the Concertina counter with more than one module is based on a left-to-right sequence (seen from the person's view sitting behind the counter).

BASE MODULES

The base module has a lower dual front panel, a cable carrier, an upper front panel and two end frames. The end frames are fitted with a rubberized half round PVC bumper in medium grey placed on the user side and supplied with two actuators.

The base modules are available as:

- Two optional widths (110 or 150 cm)
- Straight and curved modules (45° or 60°)
- Fixed height (standard 72 cm) or electronically adjustable (70 - 120 cm)
- Freestanding or connected modules (starter and add-on)
- Front panel in steel or wood
- Upper front panel in solid steel or perforated steel

UPPER FRONT PANELS

The upper front panel has either a solid steel or steel perforated surface. It is fastened underneath the counter top and follows the counter top up and down (if height adjustable module).

COUNTER TOPS

The counter tops are supplied with solid, grey, flexible, rubberized PVC edges. The counter tops are available as:

- Three optional depths (66, 78 or 90 cm)
- Four optional functions (freestanding, left side free, middle, right side free)
- Optional widths depending on base module width:
 - 110 cm base = 110, 130 or 150 cm
 - 150 cm base = 150, 170 or 190 cm
- Without or with rail (low or high)
- Four designs (no projection, projection towards client, projection towards user, projection both sides)

INTERMEDIATE MODULES

The intermediate module includes a dual front panel, cable carrier and a top shelf. It is used to connect modules that do not have connecting counter tops.

ELECTRICAL WIRE TRANSFER

All end frames have a rectangular electrical wire transfer knock out on the right hand side of the end frame (when viewed from the user's side). Configurations of successive modules are prepared for wire-lead through in the end frames. The cable carrier is placed between the dual front panels on the base module, supporting any wire electrical components.

TECHNICAL SPECIFICATIONS

STEEL COMPONENTS

STEEL COMPONENTS

are powder coated with standard polyester based powders that secures high UV resistance. Powders comply with EN 45545 (fire protection - similar to DIN 4201). Thickness of the coating is 60-80 my.

The powder used includes:

- no triglycidylisocyanurate (TGIC)
- no heavy metal-containing pigments such as lead and cadmium
- no volatiles

Antibacterial equipping of surfaces upon request.



Morsø Public Library, Denmark
Two Concertina 45° curved base modules with counter tops

CONCERTINA COUNTER

DIMENSIONS

The modules for a Concertina counter vary in size. Please find important dimensions below.

HEIGHT

The Concertina counter is available in two models - fixed height (standard 72 cm) or adjustable height. Fixed height counters can be ordered in the range from 70-120 cm.

DEPTH

The straight and curved counter tops are available in three depths:

66 cm
78 cm
90 cm

WIDTH

The straight base modules are available in two widths:
110 cm
150 cm

The straight and curved counter tops are available in four widths, depending on type of module (straight/curved), counter top depth (66/78/90 cm) and curve (45°/60°):
130 cm
150 cm
170 cm
190 cm

See below for further specifications.

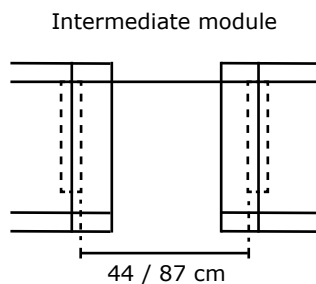
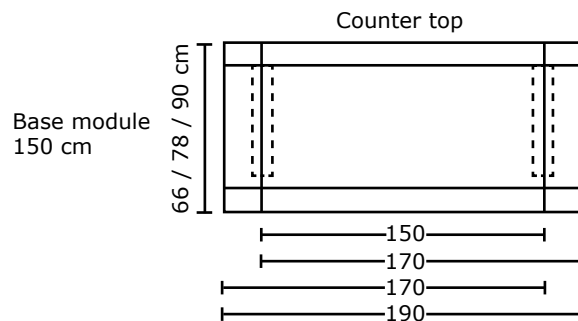
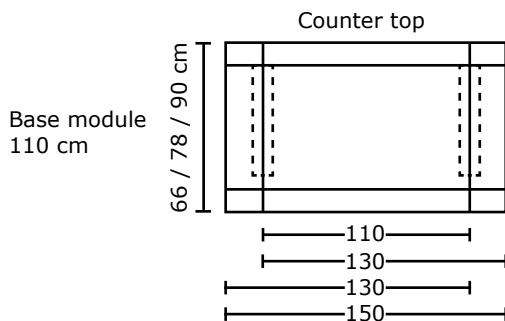

Curved modules

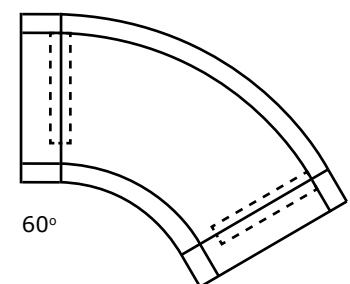
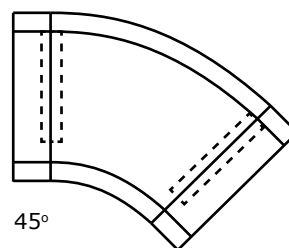

CONFIGURATION OF COUNTER TOPS

Base module	Width cm counter top
110 cm	110 cm counter top is used when connecting modules are placed on either side
110 cm	130 cm counter top is used when an adjacent module is placed on one side
110 cm	150 cm counter top is used for a freestanding module
150 cm	150 cm counter top is used when connecting modules are placed on either side
150 cm	170 cm counter top is used when an adjacent module is placed on one side
150 cm	190 cm counter top is used for a freestanding module



CONCERTINA COUNTER

CONFIGURATION

Below you will find a price example of a Concertina counter:

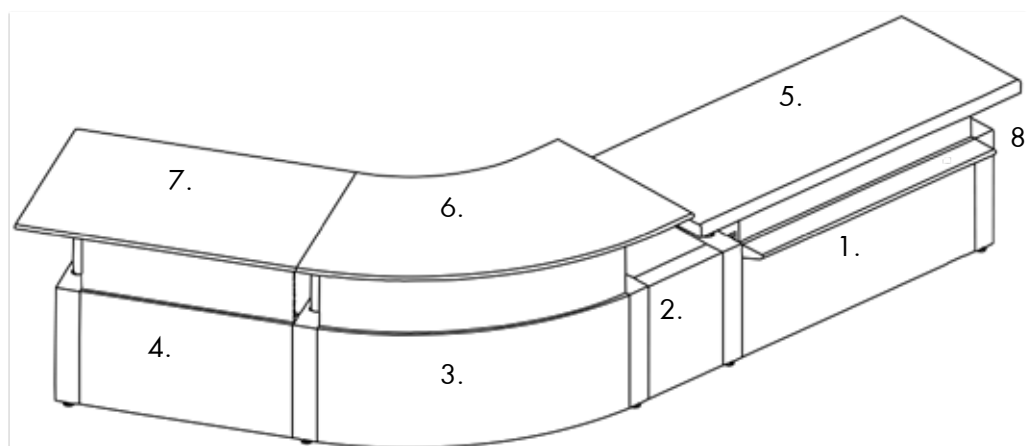
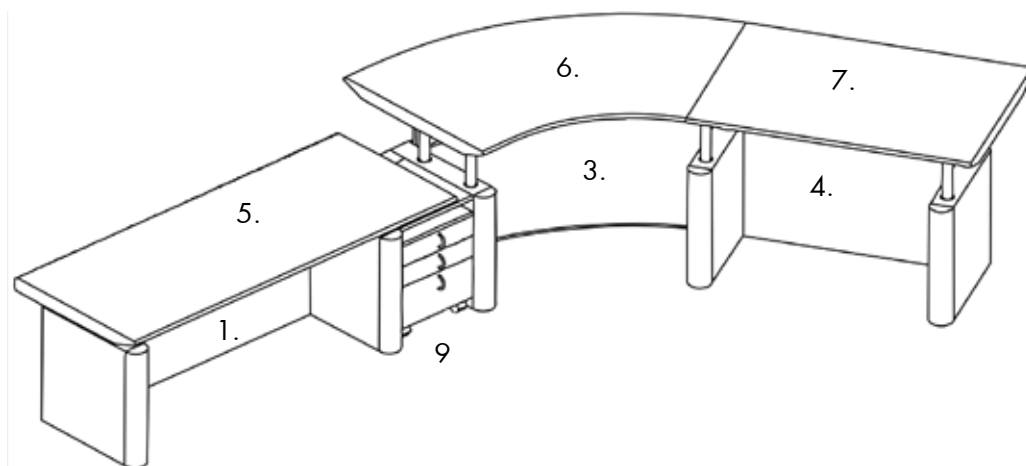

NO.	DESCRIPTION	ITEM NO.
1.	Straight start base module with steel front panel and steel upper panel. W150 cm. Fixed height 70 cm.	B36000107015340
2.	Intermediate module. W44 cm.	B360009703
3.	60° curved base module with steel front panel and steel upper panel. Electronically adjustable height.	B36000100060340
4.	Straight add-on base module with steel front panel and steel upper panel. W110 cm. Electronically adjustable height.	B36000200011340
5.	Starter freestanding straight counter top with projection towards staff. D78 cm x W190 cm.	B36002119380
6.	Starter left side free 60° curved counter top with projection on both sides. D90 cm.	B36002160470
7.	Add-on right side free straight counter top with projection on both sides. D90 cm x W130 cm.	B36002113460
8.	Bag shelf. W150 cm.	B360010153
9.	Drawer pedestal with lock, castors and 3 drawers.	B36600431
	Total	

DESIGN OPTIONS:

Base module:	BCI standard colour no. A29 Concertina grey texture*
Upper front panel:	BCI standard steel colours (for colours, see page 6)
Counter top:	BCI standard laminate #185 or linoleum #257
Drawer pedestal:	BCI standard colour no. A29 Concertina grey (for colours, see page 7)

*Other colours can be ordered at a surcharge per module of

CONCERTINA COUNTER

STRAIGHT BASE MODULES WITHOUT COUNTER TOPS - STEEL FRONT PANEL

A straight module with steel front panel and steel/perforated steel upper panel. When ordering an adjustable base module, it is necessary to mention whether it is a freestanding desk or whether it is followed by one or two add-ons.

Straight base module - with steel front panel and steel upper panel

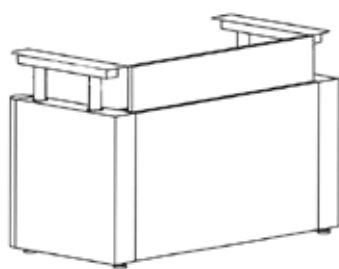

Width cm	Fixed/ Adjustable	Starter module Item no.	Add-on module Item no.
110	Fixed	B36000107211340	B36000207211340
110	Adjustable	B36000100011340	B36000200011340
150	Fixed	B36000107215340	B36000207215340
150	Adjustable	B36000100015340	B36000200015340

Straight base module - with steel front panel and perforated steel upper panel

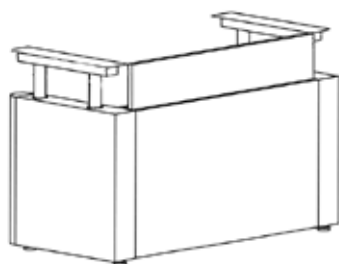

Module cm	Fixed/ Adjustable	Starter module Item no.	Add-on module Item no.
110	Fixed	B36000107211350	B36000207211350
110	Adjustable	B36000100011350	B36000200011350
150	Fixed	B36000107215350	B36000207215350
150	Adjustable	B36000100015350	B36000200015350

CONCERTINA COUNTER

STRAIGHT BASE MODULES WITHOUT COUNTER TOPS - WOODEN FRONT PANEL

A straight module with wooden front panel and steel/perforated steel upper panel. When ordering an adjustable base module, it is necessary to mention whether it is a freestanding desk or whether it is followed by one or two add-ons.

Straight base module - with wooden front panel and steel upper panel

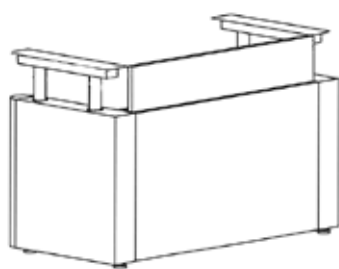

Width cm	Fixed/ Adjustable	Starter module Item no.	Add-on module Item no.
110	Fixed	B36000107211440	B36000207211440
110	Adjustable	B36000100011440	B36000200011440
150	Fixed	B36000107215440	B36000207215440
150	Adjustable	B36000100015440	B36000200015440

Straight base module - with wooden front panel and perforated steel upper panel

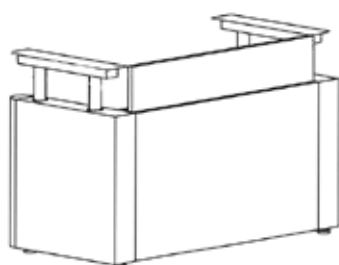

Module cm	Fixed/ Adjustable	Starter module Item no.	Add-on module Item no.
110	Fixed	B36000107211450	B36000207211450
110	Adjustable	B36000100011450	B36000200011450
150	Fixed	B36000107215450	B36000207215450
150	Adjustable	B36000100015450	B36000200015450

CONCERTINA COUNTER

CURVED BASE MODULES WITHOUT COUNTER TOPS - STEEL FRONT PANEL

A curved module with steel front panel and steel/perforated steel upper panel. When ordering an adjustable base module, it is necessary to mention whether it is a freestanding desk or whether it is followed by one or two add-ons. We do not recommend using 45° counters as freestanding due to minimal legroom between the end frames.

Curved base module - with steel front panel and steel upper panel

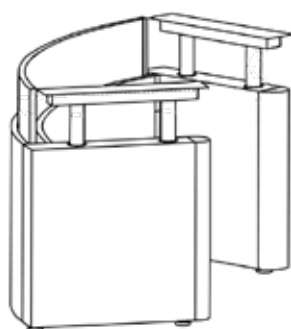

Curve	Fixed/ Adjustable	Starter module Item no.	Add-on module Item no.
45°	Fixed	B36000107245340	B36000207245340
45°	Adjustable	B36000100045340	B36000200045340
60°	Fixed	B36000107260340	B36000207260340
60°	Adjustable	B36000100060340	B36000200060340

Curved base module - with steel front panel and perforated steel upper panel

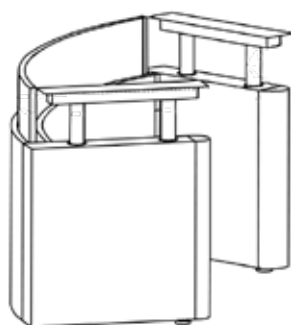

Curve	Fixed/ Adjustable	Starter module Item no.	Add-on module Item no.
45°	Fixed	B36000107245350	B36000207245350
45°	Adjustable	B36000100045350	B36000200045350
60°	Fixed	B36000107260350	B36000207260350
60°	Adjustable	B36000100060350	B36000200060350

CONCERTINA COUNTER

CURVED BASE MODULES WITHOUT COUNTER TOPS - WOODEN FRONT PANEL

A curved module with wooden front panel and steel/perforated steel upper panel. When ordering an adjustable base module, it is necessary to mention whether it is a freestanding desk or whether it is followed by one or two add-ons. We do not recommend using 45° counters as freestanding due to minimal legroom between the end frames.

Curved base module - with wooden front panel and steel upper panel

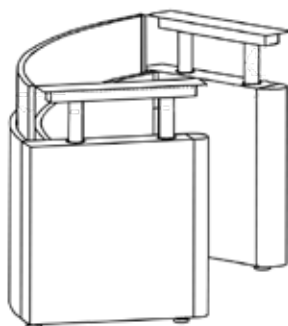

Curve	Fixed/ Adjustable	Starter module Item no.	Add-on module Item no.
45°	Fixed	B36000107245440	B36000207245440
45°	Adjustable	B36000100045440	B36000200045440
60°	Fixed	B36000107260440	B36000207260440
60°	Adjustable	B36000100060440	B36000200060440

Curved base module - with wooden front panel and perforated steel upper panel

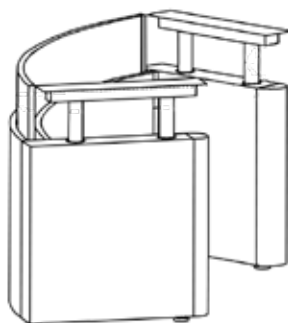

Curve	Fixed/ Adjustable	Starter module Item no.	Add-on module Item no.
45°	Fixed	B36000107245450	B36000207245450
45°	Adjustable	B36000100045450	B36000200045450
60°	Fixed	B36000107260450	B36000200060450
60°	Adjustable	B36000100060450	B36000207260450

CONCERTINA COUNTER

INTERMEDIATE MODULE - STEEL/WOODEN FRONT PANEL

The intermediate module is used when the counter top is wider than the base.

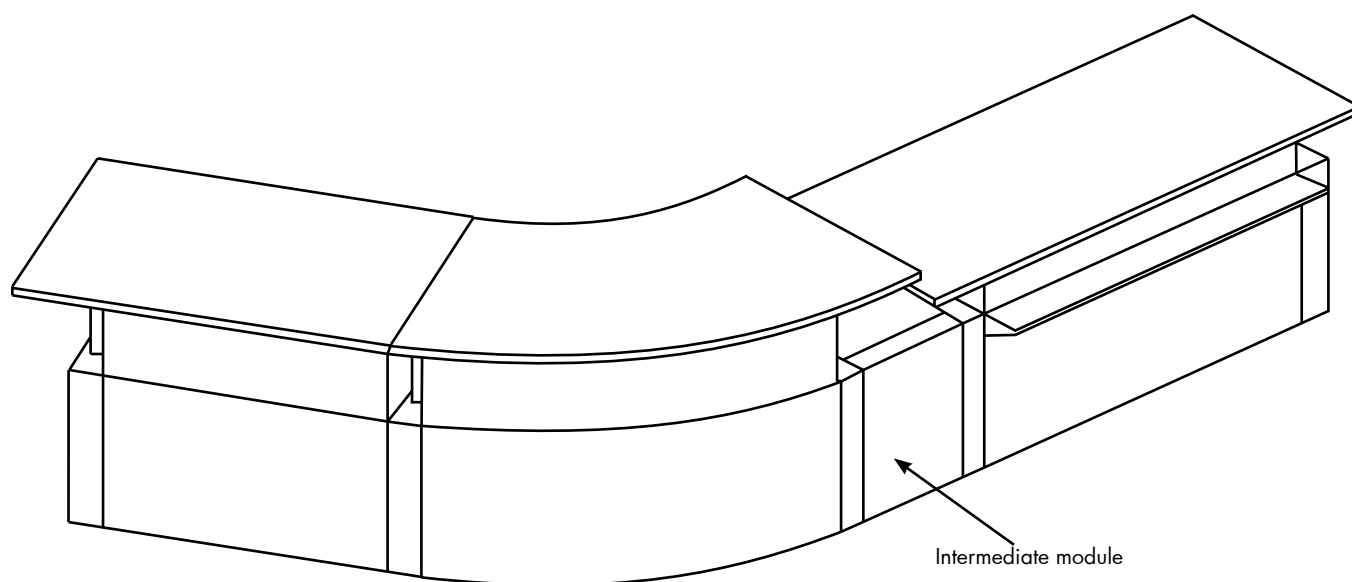

Intermediate module - with steel front panel

Width cm	Item no.
44	B360009703
87	B360009873

Intermediate module - with wooden front panel (beech wood)

Width cm	Item no.
44	B360009704
87	B360009874

CONCERTINA COUNTER

COUNTER TOPS FOR STRAIGHT BASE MODULE

The counter tops are available in four models; no projection, projection towards client, projection towards staff, and projection on both sides. Furthermore the counter tops are prepared for either freestanding, left side free, middle and right side free modules all depending on the position of the module. Note the construction of the Concertina counter is based on a left-to-right sequence (seen from the person's view sitting behind the counter).

No projection - depth 66 cm - for straight base module

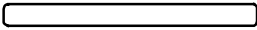
	Model	Width cm	Item no.
	Freestanding	150	B36002115180
	Freestanding	190	B36002119180
	Right side free	130	B36002113160
	Right side free	170	B36002117160
	Middle	110	B36002111150
	Middle	150	B36002115150
	Left side free	130	B36002113170
	Left side free	170	B36002117170

Projection towards client - depth 78 cm - for straight base module

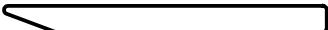
	Model	Width cm	Item no.
	Freestanding	150	B36002115280
	Freestanding	190	B36002119280 1
	Right side free	130	B36002113260
	Right side free	170	B36002117260
	Middle	110	B36002111250
	Middle	150	B36002115250
	Left side free	130	B36002113270
	Left side free	170	B36002117270

Projection towards staff - depth 78 cm - for straight base module

	Model	Width cm	Item no.
	Freestanding	150	B36002115380
	Freestanding	190	B36002119380 1
	Right side free	130	B36002113360
	Right side free	170	B36002117360
	Middle	110	B36002111350
	Middle	150	B36002115350
	Left side free	130	B36002113370
	Left side free	170	B36002117370

Projection on both sides - depth 90 cm - for straight base module

	Model	Width cm	Item no.
	Freestanding	150	B36002115480
	Freestanding	190	B36002119480
	Right side free	130	B36002113460
	Right side free	170	B36002117460
	Middle	110	B36002111450
	Middle	150	B36002115450
	Left side free	130	B36002113470
	Left side free	170	B36002117470

CONCERTINA COUNTER

COUNTER TOPS FOR STRAIGHT BASE MODULE - WITH LOW RAIL

The counter tops are also available with a low rail (inner height 25 cm) that is fixed onto the counter top.

No projection - depth 66 cm - for straight base module

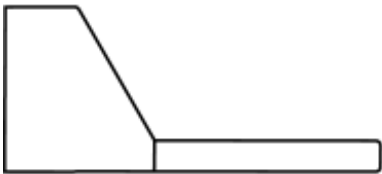

Model	Width cm	Item no.
Freestanding	150	B36002115181
Freestanding	190	B36002119181
Right side free	130	B36002113161
Right side free	170	B36002117161
Middle	110	B36002111151
Middle	150	B36002115151
Left side free	130	B36002113171
Left side free	170	B36002117171

Projection towards client - depth 78 cm - for straight base module

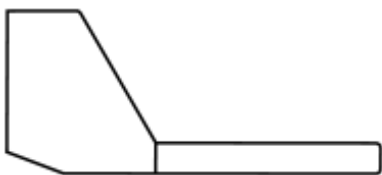

Model	Width cm	Item no.
Freestanding	150	B36002115281
Freestanding	190	B36002119281
Right side free	130	B36002113261
Right side free	170	B36002117261
Middle	110	B36002111251
Middle	150	B36002115251
Left side free	130	B36002113271
Left side free	170	B36002117271

Projection towards staff - depth 78 cm - for straight base module

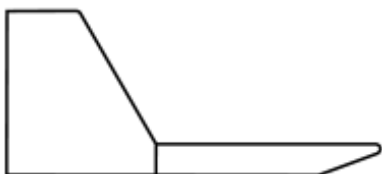

Model	Width cm	Item no.
Freestanding	150	B36002115381
Freestanding	190	B36002119381
Right side free	130	B36002113361
Right side free	170	B36002117361
Middle	110	B36002111351
Middle	150	B36002115351
Left side free	130	B36002113371
Left side free	170	B36002117371

Projection on both sides - depth 90 cm - for straight base module

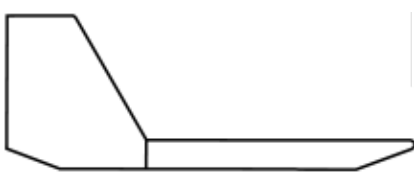

Model	Width cm	Item no.
Freestanding	150	B36002115481
Freestanding	190	B36002119481
Right side free	130	B36002113461
Right side free	170	B36002117461
Middle	110	B36002111451
Middle	150	B36002115451
Left side free	130	B36002113471
Left side free	170	B36002117471

CONCERTINA COUNTER

COUNTER TOPS FOR STRAIGHT BASE MODULE - WITH HIGH RAIL

The counter tops are also available with a high rail (inner height 35 cm) that is fixed onto the counter top.

No projection - depth 66 cm - for straight base module

	Model	Width cm	Item no.
	Freestanding	150	B36002115182
	Freestanding	190	B36002119182
	Right side free	130	B36002113162
	Right side free	170	B36002117162
	Middle	110	B36002111152
	Middle	150	B36002115152
	Left side free	130	B36002113172
	Left side free	170	B36002117172

Projection towards client - depth 78 cm - for straight base module

	Model	Width cm	Item no.
	Freestanding	150	B36002115282
	Freestanding	190	B36002119282
	Right side free	130	B36002113262
	Right side free	170	B36002117262
	Middle	110	B36002111252
	Middle	150	B36002115252
	Left side free	130	B36002113272
	Left side free	170	B36002117272

Projection towards staff - depth 78 cm - for straight base module

	Model	Width cm	Item no.
	Freestanding	150	B36002115382
	Freestanding	190	B36002119382
	Right side free	130	B36002113362
	Right side free	170	B36002117362
	Middle	110	B36002111352
	Middle	150	B36002115352
	Left side free	130	B36002113372
	Left side free	170	B36002117372

Projection on both sides - depth 90 cm - for straight base module

	Model	Width cm	Item no.
	Freestanding	150	B36002115482
	Freestanding	190	B36002119482
	Right side free	130	B36002113462
	Right side free	170	B36002117462
	Middle	110	B36002111452
	Middle	150	B36002115452
	Left side free	130	B36002113472
	Left side free	170	B36002117472

CONCERTINA COUNTER

COUNTER TOPS FOR 45° CURVED BASE MODULE

The counter tops are available in four models; no projection, projection towards client, projection towards staff, and projection on both sides. Furthermore the counter tops are prepared for either freestanding, left side free, middle and right side free modules all depending on the position of the module. Note the construction of the Concertina counter is based on a left-to-right sequence (seen from the person's view sitting behind the counter).

No projection - depth 66 cm - for 45° curved base module

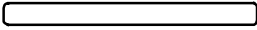
	Model	Item no.
	Freestanding	Not available
	Right side free	B36002145160 1.
	Middle	B36002145150
	Left side free	B36002145170 1.

Projection towards client - depth 78 cm - for 45° curved base module

	Model	Item no.
	Freestanding	Not available
	Right side free	B36002145260
	Middle	B36002145250
	Left side free	B36002145270

Projection towards staff - depth 78 cm - for 45° curved base module

	Model	Item no.
	Freestanding	Not available
	Right side free	B36002145360
	Middle	B36002145350
	Left side free	B36002145370

Projection on both sides - depth 90 cm - for 45° curved base module

	Model	Item no.
	Freestanding	Not available
	Right side free	B36002145460
	Middle	B36002145450
	Left side free	B36002145470

CONCERTINA COUNTER

COUNTER TOPS FOR 45° CURVED BASE MODULE - WITH LOW RAIL

The counter tops are also available with a low rail (inner height 25 cm) that is fixed onto the counter top.

No projection - depth 66 cm - for 45° curved base module - with low rail

	Model	Item no.
	Freestanding	Not available
	Right side free	B36002145161
	Middle	B36002145151
	Left side free	B36002145171

Projection towards client - depth 78 cm - for 45° curved base module - with low rail

	Model	Item no.
	Freestanding	Not available
	Right side free	B36002145261
	Middle	B36002145251
	Left side free	B36002145271

Projection towards staff - depth 78 cm - for 45° curved base module - with low rail

	Model	Item no.
	Freestanding	Not available
	Right side free	B36002145361
	Middle	B36002145351
	Left side free	B36002145371

Projection on both sides - depth 90 cm - for 45° curved base module - with low rail

	Model	Item no.
	Freestanding	Not available
	Right side free	B36002145461
	Middle	B36002145451
	Left side free	B36002145471

CONCERTINA COUNTER

COUNTER TOPS FOR 45° CURVED BASE MODULE - WITH HIGH RAIL

The counter tops are also available with a high rail (inner height 35 cm) that is fixed onto the counter top.

No projection - depth 66 cm - for 45° curved base module - with high rail

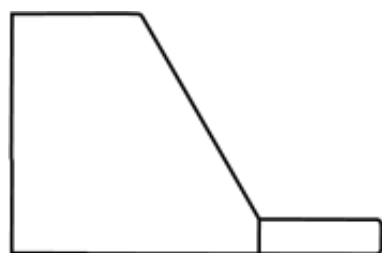

Model	Item no.
Freestanding	Not available
Right side free	B36002145162
Middle	B36002145152
Left side free	B36002145172

Projection towards client - depth 78 cm - for 45° curved base module - with high rail

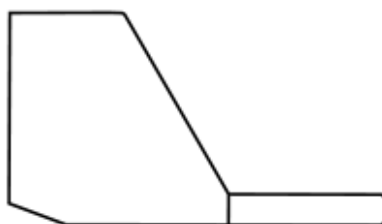

Model	Item no.
Freestanding	Not available
Right side free	B36002145262
Middle	B36002145252
Left side free	B36002145272

Projection towards staff - depth 78 cm - for 45° curved base module - with high rail

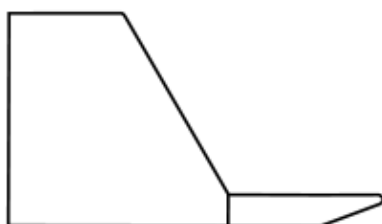

Model	Item no.
Freestanding	Not available
Right side free	B36002145362
Middle	B36002145352
Left side free	B36002145372

Projection on both sides - depth 90 cm - for 45° curved base module - with high rail

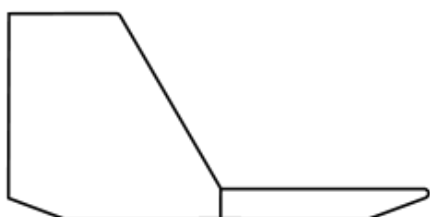

Model	Item no.
Freestanding	Not available
Right side free	B36002145462
Middle	B36002145452
Left side free	B36002145472

CONCERTINA COUNTER

COUNTER TOPS FOR 60° CURVED BASE MODULE

The counter tops are available in four models; no projection, projection towards client, projection towards staff, and projection on both sides. Furthermore the counter tops are prepared for either freestanding, left side free, middle and right side free modules all depending on the position of the module. Note the construction of the Concertina counter is based on a left-to-right sequence (seen from the person's view sitting behind the counter).

No projection - depth 66 cm - for 60° curved base module

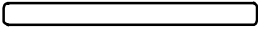
	Model	Item no.
	Freestanding	B36002160180
	Right side free	B36002160160
	Middle	B36002160150
	Left side free	B36002160170

Projection towards client - depth 78 cm - for 60° curved base module

	Model	Item no.
	Freestanding	B36002160280
	Right side free	B36002160260
	Middle	B36002160250
	Left side free	B36002160270

Projection towards staff - depth 78 cm - for 60° curved base module

	Model	Item no.
	Freestanding	B36002160380
	Right side free	B36002160360
	Middle	B36002160350
	Left side free	B36002160370

Projection on both sides - depth 90 cm - for 60° curved base module

	Model	Item no.
	Freestanding	B36002160480
	Right side free	B36002160460
	Middle	B36002160450
	Left side free	B36002160470

CONCERTINA COUNTER

COUNTER TOPS FOR 60° CURVED BASE MODULE - WITH LOW RAIL

The counter tops are also available with a low rail (inner height 25 cm) that is fixed onto the counter top.

No projection - depth 66 cm - for 60° curved base module - with low rail

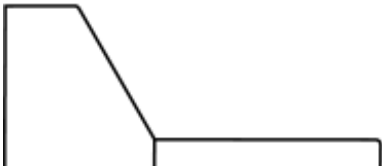
	Model	Item no.
	Freestanding	B36002160181
	Right side free	B36002160161
	Middle	B36002160151
	Left side free	B36002160171

Projection towards client - depth 78 cm - for 60° curved base module - with low rail

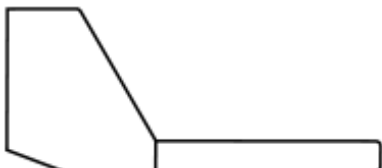
	Model	Item no.
	Freestanding	B36002160281
	Right side free	B36002160261
	Middle	B36002160251
	Left side free	B36002160271

Projection towards staff - depth 78 cm - for 60° curved base module - with low rail

	Model	Item no.
	Freestanding	B36002160381
	Right side free	B36002160361
	Middle	B36002160351
	Left side free	B36002160371

Projection on both sides - depth 90 cm - for 60° curved base module - with low rail

	Model	Item no.
	Freestanding	B36002160481
	Right side free	B36002160461
	Middle	B36002160451
	Left side free	B36002160471

CONCERTINA COUNTER

COUNTER TOPS FOR 60° CURVED BASE MODULE - WITH HIGH RAIL

The counter tops are also available with a high rail (inner height 35 cm) that is fixed onto the counter top.

No projection - depth 66 cm - for 60° curved base module - with high rail

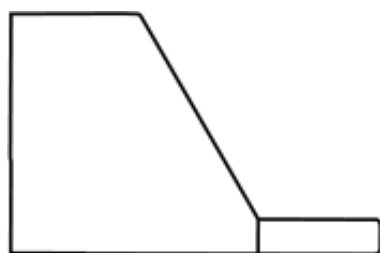

Model	Item no.
Freestanding	B36002160182
Right side free	B36002160162
Middle	B36002160152
Left side free	B36002160172

Projection towards client - depth 78 cm - for 60° curved base module - with high rail

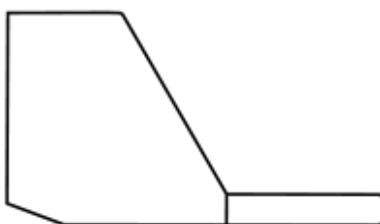

Model	Item no.
Freestanding	B36002160282
Right side free	B36002160262
Middle	B36002160252
Left side free	B36002160272

Projection towards staff - depth 78 cm - for 60° curved base module - with high rail

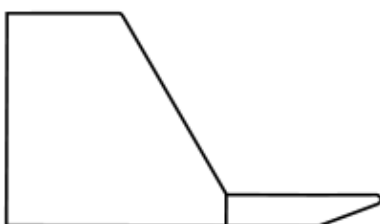

Model	Item no.
Freestanding	B36002160382
Right side free	B36002160362
Middle	B36002160352
Left side free	B36002160372

Projection on both sides - depth 90 cm - for 60° curved base module - with high rail

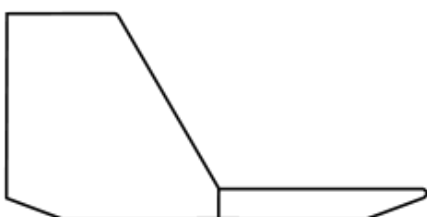

Model	Item no.
Freestanding	B36002160482
Right side free	B36002160462
Middle	B36002160452
Left side free	B36002160472

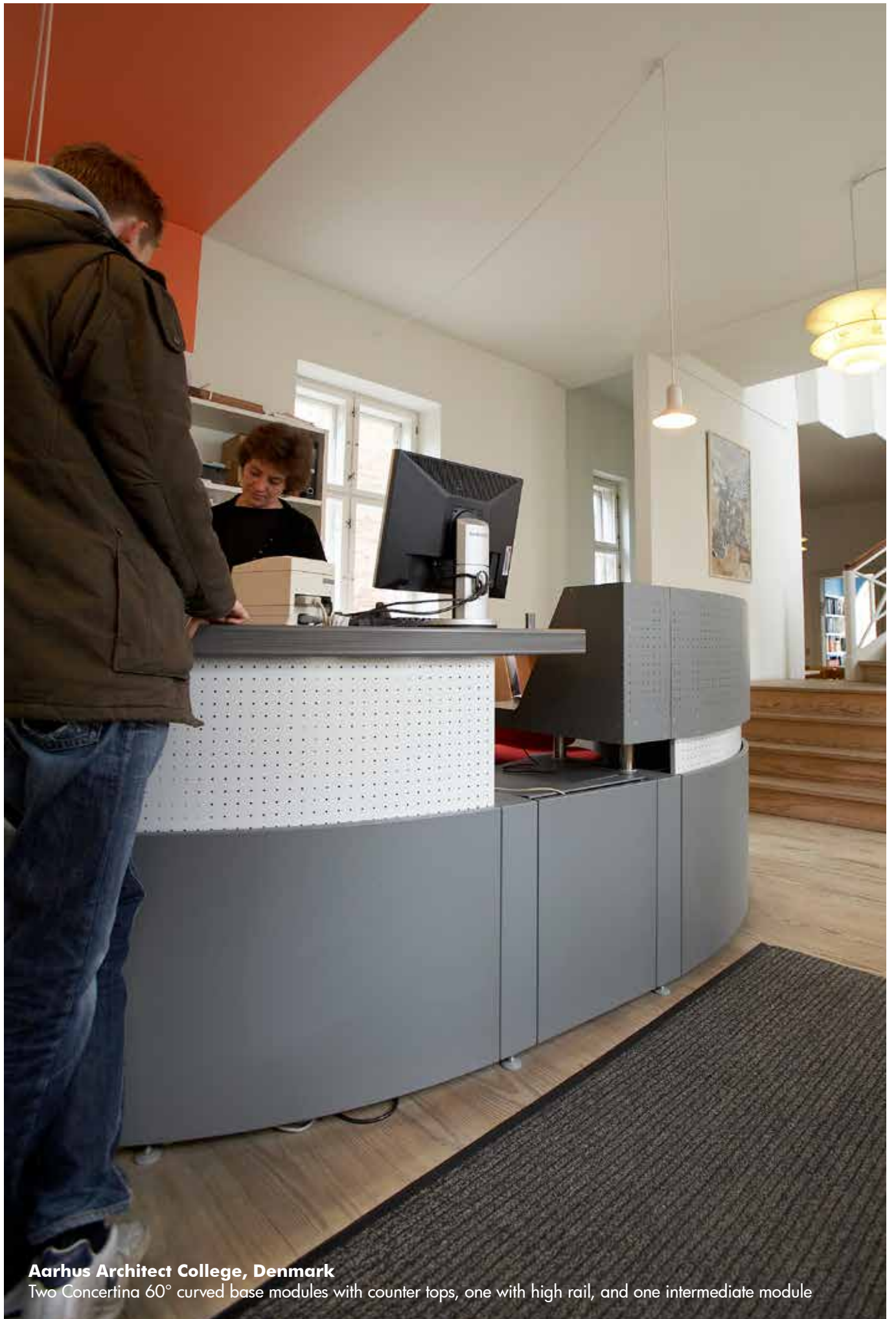

Aarhus Architect College, Denmark

Two Concertina 60° curved base modules with counter tops, one with high rail, and one intermediate module

CONCERTINA COUNTER

ACCESSORIES

Drawer pedestal with central lock and castors

Dimensions cm H x W x D	Drawe	Item no.
49 x 42.4 x 42.4	2	B36600421
49 x 42.4 x 42.4	3	B36600431

Shelf pedestal

Dimensions cm H x W x D	With/without castors	Shelve	Item no.
49 x 42.4 x 42.4	With	1	B36600111
49 x 42.4 x 42.4	With	2	B36600121
42.5 x 42.4 x 42.4	Without	1	B36600110
42.5 x 42.4 x 42.4	Without	2	B36600120

Base for shelf pedestal without castors

Item no.

B366010

CPU holder

Item no.

B367025

CONCERTINA COUNTER

ACCESSORIES

Pigeon hole

Type	Item no.
Low	B3670004
High	B3670005

Insert for pigeon hole component

Size	Item no.
Small	B3670102
Large	B3670101

Shelf

Incl. brackets	Width cm	Item no.
	110	B36606511
	150	B36606515

Bag shelf

Incl. brackets	For base module	For steel front Item no.	For wooden front Item no.
	110 cm straight counter	B360010113	B360010114
	150 cm straight counter	B360010153	B360010154
	45° curved counter	B360010453	B360010454
	60° curved counter	B360010603	B360010604

CONCERTINA COUNTER

ACCESSORIES

Pen drawer

With/without
lock

Item no.

Without

B3660501

With

B3660502

Horizontal divider

Item no.

B367020

Office supply tray

Item no.

B367021

COORDONNÉES

WE ARE LIBRARY PEOPLE®



DANEMARK

Lammhults Biblioteksdesign A/S
Dalbækvej 1
6670 Holsted

bci@bci.dk
www.bci.dk

FRANCE

BC Intérieur Sarl
8, Allée Lorentz
77420 Champs sur Marne

bci@bcinterieur.com
www.bcinterieur.fr

BELGIQUE

SBNL - Schulz Benelux BVBA
Appelweg 94 C
3221 Holsbeek

info@sbnl.be
www.sbnl.be

SUÈDE

Lammhults Biblioteksdesign AB
Odlarevägen 16
226 60 Lund

eurobib@eurobib.se
www.eurobib.se

ALLEMAGNE

Schulz Speyer Bibliothekstechnik AG
Friedrich-Ebert-Straße 2a
67346 Speyer

sales@schulzspeyer.de
www.schulzspeyer.de

ROYAUME-UNI

thedesignconcept Ltd.
The Old Bakery,
10 Greenless Road
Cambuslang Belgrave Street
Glasgow G72 8JJ

info@thedesignconcept.co.uk
www.thedesignconcept.co.uk

NORVÈGE

BS Eurobib AS
Alf Bjerckes vei 20
0582 Oslo

post@bseurobib.no
www.bseurobib.no